

# KENWOOD

**KMD-860R**

MD-RECEIVER  
**INSTRUCTION MANUAL**

KENWOOD CORPORATION



US and foreign patents licensed from Dolby Laboratories  
Licensing Corporation.

© PRINTED IN JAPAN B64-1199-00 (E) (MC)  
99/2 1 98/12 11 10 9 8 7 6 5 4 3 2

## Contents

### Before use

Safety precautions .....	3
--------------------------	---

### Buttons and Display

Basic operations .....	5
Tuner features .....	5
RDS features .....	6
Disc control features .....	6
Other features .....	7
Steering remote control .....	7
Remote control .....	7

### Basic operations

Power .....	8
Switching Modes .....	8
Volume .....	8
Attenuator .....	8
Loudness .....	8
Menu System .....	8

### Tuner features

Selecting Tuning Mode .....	10
Tuning .....	10
Local Seek Function .....	11
Monaural Reception .....	11
Station Preset Memory .....	11
Auto Memory Entry .....	12
Direct Access Tuning .....	12
Preset station seek with Programme service name .....	13
Switching Display for Tuner (non-RDS station) .....	13

### RDS features

RDS (Radio Data System) .....	14
EON (Enhanced Other Network) .....	14
Alarm .....	14
AF(Alternative Frequency) Function .....	14
Restricting RDS Region (Region Restrict Function) .....	15
Traffic Information Function .....	15
Auto TP Seek Function .....	16
Presetting Volume for Traffic Information/News .....	16
News Bulletin Function with PTY News Timeout Setting .....	17
Programme Type (PTY) Function .....	18

### Disc control features

Playing MDs .....	19
-------------------	----

Playing Other Disc mode .....	20
Fast Forwarding and Reversing Disc Play .....	21
Track Search .....	21
Disc Search .....	21
Track/Disc Repeat Function .....	22
Track Scan Function .....	22
Disc Scan Function .....	22
Random Play Function .....	23
Magazine Random Play Function .....	23
Switching Display for Discs .....	24
Text/Title Scroll .....	24
Direct Track Search .....	25
Direct Disc Search .....	25
Presetting Disc Names .....	26
Disc Name Preset Play (DNPP) .....	27

### Other features

Audio Control Setting .....	28
Table of Audio Control Setting .....	28
Switching Preout .....	29
TEL Mute Function .....	29
Navigation Mute Function .....	29
Selectable Illumination .....	30
Automatic Dimmer Function .....	30
Switching Clock Display .....	30
Touch Sensor Tone .....	30
Switching Graphic Display .....	31
DSI (Disabled System Indicator) .....	31
Adjusting Time .....	32
Theft Deterrent Faceplate .....	33

### Basic operations of remote control (optional) .....

### Basic operations of steering remote control .....

### Installation

Accessories .....	37
Installation Procedure .....	37
Connecting Cables to Terminals .....	38
Installation .....	39
Attaching Steering Remote Control .....	41

### Troubleshooting Guide .....

### Specifications .....

## Safety precautions

### **⚠WARNING**

#### **To prevent injury and/or fire, take the following precautions:**

- Insert the unit all the way until it is fully locked in place. Otherwise it may fly out of place during collisions and other jolts.
- When extending the ignition, battery or ground cables, make sure to use automotive-grade cables or other cables with an area of 0.75mm<sup>2</sup> (AWG18) or more to prevent cable deterioration and damage to the cable coating.
- To prevent short circuits, never put or leave any metallic objects (e.g., coins or metal tools) inside the unit.
- If the unit starts to emit smoke or strange smells, turn off the power immediately and consult your Kenwood dealer.
- Make sure not to get your fingers caught between the faceplate and the unit.
- Be careful not to drop the unit or subject it to strong shock.  
The unit may break or crack because it contains glass parts.
- Do not touch the liquid crystal fluid if the LCD is damaged or broken due to shock. The liquid crystal fluid may be dangerous to your health or even fatal.  
If the liquid crystal fluid from the LCD contacts your body or clothing, wash it off with soap immediately.

### **⚠CAUTION**

#### **To prevent damage to the machine, take the following precautions:**

- Make sure to ground the unit to a negative 12V DC power supply.
- Do not open the top or bottom covers of the unit.
- Do not install the unit in a spot exposed to direct sunlight or excessive heat or humidity. Also avoid places with too much dust or the possibility of water splashing.
- Do not set the removed faceplate or the faceplate case in areas exposed to direct sunlight, excessive heat or humidity. Also avoid places with too much dust or the possibility of water splashing.
- Do not subject the faceplate to excessive shock, as it is a piece of precision equipment.
- To prevent deterioration, do not touch the terminals of the unit or faceplate with your fingers.
- When replacing a fuse, only use a new one with the prescribed rating. Using a fuse with the wrong rating may cause your unit to malfunction.
- To prevent short circuits when replacing a fuse, first disconnect the wiring harness.
- Do not place any object between the faceplate and the unit.
- During installation, do not use any screws except for the ones provided. The use of improper screws might result in damage to the main unit.

### **IMPORTANT INFORMATION**

*You cannot connect the unit directly to the following CD automatic changers. For users who want to use older changers with the unit, follow the directions below according to the type of changer you own:*

#### **• KDC-C200 / KDC-C300 / KDC-C400**

Use the extension cable and the control box attached to the CD changer, and the optional CA-DS100 converter cable.

#### **• KDC-C301 / KDC-C600 / KDC-C800 / KDC-C601 / KDC-C401**

Use the extension cable attached to the CD changer, and the optional CA-DS100 converter cable.

#### **• KDC-C100 / KDC-C302 / C205 / C705 / non-Kenwood CD changers**

Cannot be used with this model.

### **⚠CAUTION**

***You can damage both your unit and the CD changer if you connect them incorrectly.***

## Safety precautions

### NOTE

- If you experience problems during installation, consult your Kenwood dealer.
- If the unit does not seem to be working right, try pressing the reset button first. If that does not solve the problem, consult your Kenwood dealer.

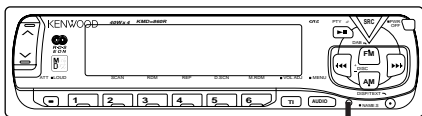

Reset button

### Cleaning the Unit

If the front panel gets dirty, turn off the power and wipe the panel with a dry silicon cloth or soft cloth.

### CAUTION

Do not wipe the panel with a stiff cloth or a cloth dampened by volatile solvents such as paint thinner and alcohol. They can scratch the surface of the panel and/or cause the indicator letters to peel off.

### Cleaning the Faceplate Terminals

If the terminals on the unit or faceplate get dirty, wipe them with a dry, soft cloth.

### Handling Mini discs

- The MD shutter is designed so that it cannot be opened. If forced open, the cartridge will be damaged and use of the MD will no longer be possible. If the shutter has been opened due to some cause, be careful not to touch the recording portion with a finger. Doing so will cause the sound to skip.

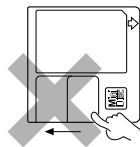

- Do not use an MD that has a peeling label. Use of an MD that has a loose or peeling label may cause problems, such as the label coming off inside the player and the resultant inability to eject the MD.
- Wipe away dirt or dust from the cartridge surface with a dry cloth before use. Using an oil-soiled cartridge in particular may result in the disc not loading or being unable to eject it. (At time of cleaning, be careful not to open the shutter.)
- Do not leave the MD in the unit for a prolonged period. The ejected MD should be placed in an MD case for storage.
- Do not leave the MD in a place exposed to direct sunlight (such as on a instrument panel) or in other places that reach high temperatures. The MD cartridge will become misshapen and will no longer be usable.
- MDs designed for use with data cannot be used. Please use MDs designed for music.
- Do not use lens cleaners. Doing so will lead to breakdown.

### Lens Fogging

In cold climates, there may be a period after you turn on your vehicle's heater when the lens that guides the laser beam used in your MD player fogs up. If this happens, you cannot play mini discs. Take out discs and the fogging will disappear. If it does not return to normal after several hours, contact your Kenwood dealer.

### The marking of products using lasers (Except for some areas)

## CLASS 1 LASER PRODUCT

The label is attached to the chassis/case and says that the component uses laser beams that have been classified as Class 1. It means that the unit is utilizing laser beams that are of a weaker class. There is no danger of hazardous radiation outside the unit.

# Buttons and Display

## Basic operations

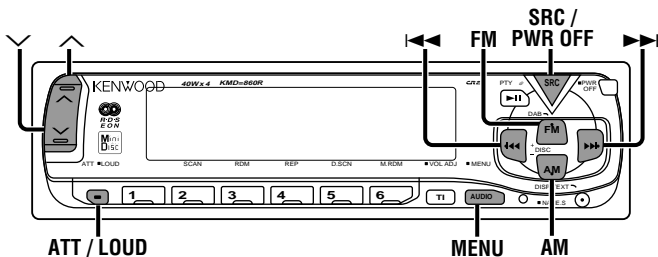

## Tuner features

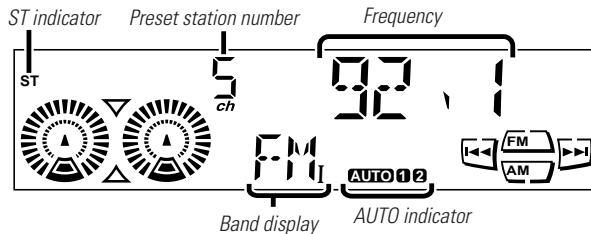
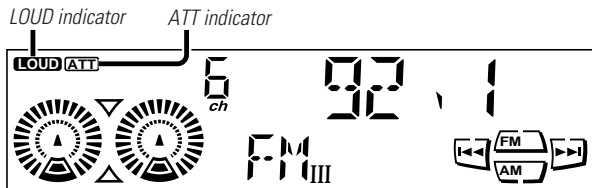
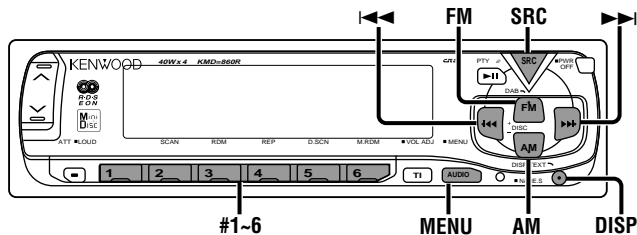

## Buttons and Display

### RDS features

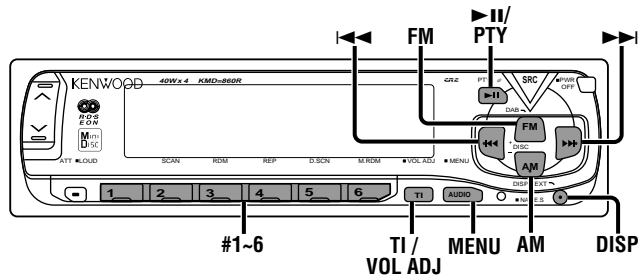

### Disc control features

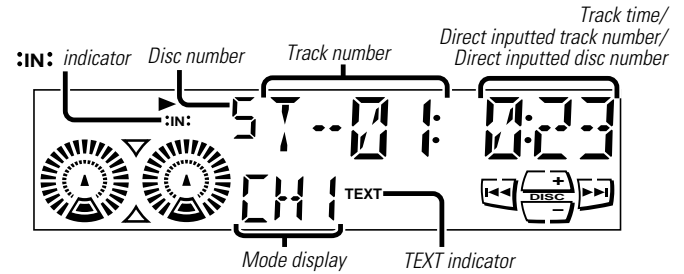
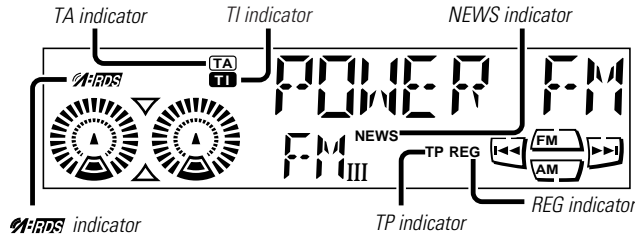
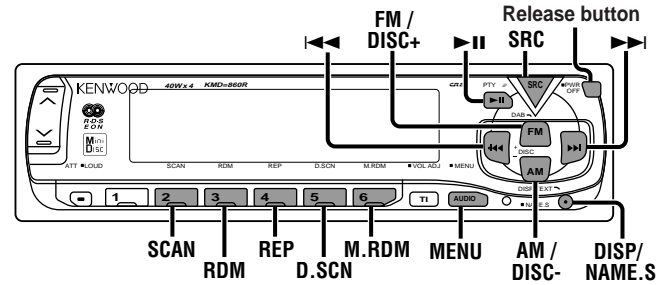

## Other features

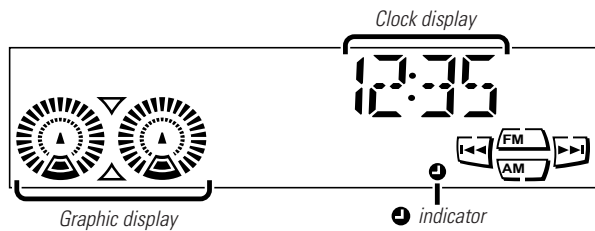
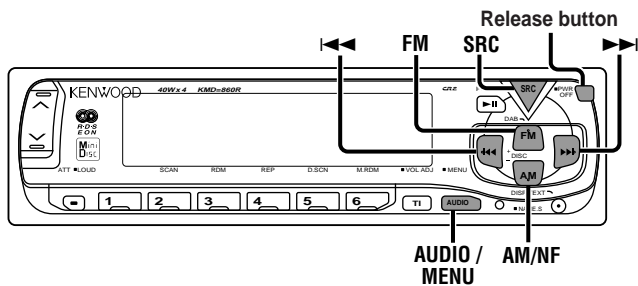

## Steering remote control

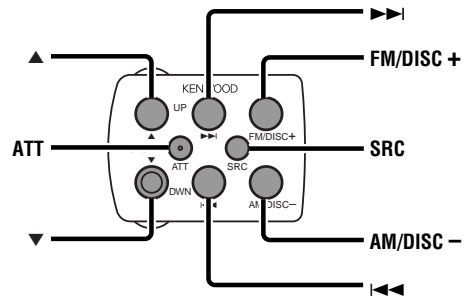

## Remote control

*Optional*

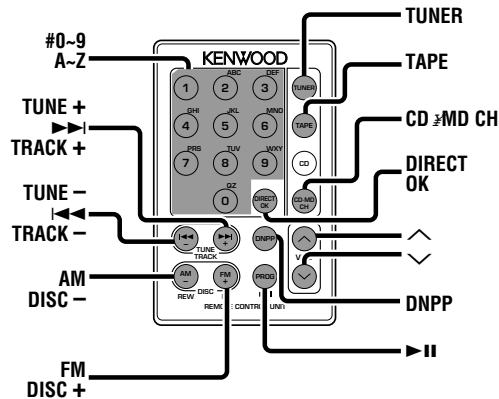

### NOTE

Pressing the TAPE button will switch the unit to the MD mode.

## Basic operations (See page 5)

### Power

#### Turning on the power:

Press the SRC button.

#### NOTE

Turn the power on before carrying out the following procedures.

#### Turning off the power:

Hold down the PWR OFF button for one second or more.

### Switching Modes

#### Switching Modes:

Each time you press the SRC button, the mode switches as follows:

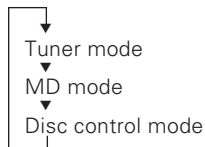

#### NOTE

- The mode switches to the next mode from any mode which cannot be used.
- The disc control mode will differ depending on the unit that is connected.

### Volume

#### Increasing Volume:

Press the  $\wedge$  button to turn up the volume.

#### Decreasing Volume:

Press the  $\vee$  button to turn down the volume.

### Attenuator

This function allows you to turn down the volume quickly.

#### Turning Attenuator On/Off:

Press the ATT button to switch the attenuator on and off.

When the attenuator is on, the ATT indicator blinks.

When the attenuator is off, the volume returns to the original level.

#### NOTE

Turning down the volume all the way turns off the attenuator function.

### Loudness

This function amplifies low and high tones when the volume is turned down.

The LOUD indicator lights up, when the loudness function is on.

#### Turning Loudness On/Off:

Hold down the LOUD button for one second or more to switch the loudness on and off.

### Menu System

To accommodate a greater number of functions, a menu system has been employed for making settings. Press the MENU button to enter the menu mode and then display the function to make the setting. Details on each setting are explained separately in the corresponding function page.

- 1 Hold down the MENU button for one second or more. "MENU" is displayed when the menu mode is entered. The function that you can adjust is indicated with the current settings displayed.
- 2 **Selecting function to set**  
Press the  $\blacktriangleright$  button to search through the functions until you see the one you want to adjust in the display.



Press the ◀◀ button to search through the functions backward.

Example: If you want to switch the tuning mode from AUTO1 to manual, first search through the functions until you see "AUTO 1" in the display.

AUTO 1

### 3 Changing setting for currently displayed function

Press either the AM or FM button.

The setting will change for each function.

Example: The tuning mode will switch from AUTO 1 to AUTO 2. Pressing the button again switches the setting to manual, and "MANUAL" is displayed.

AUTO 2 → MANUAL

### 4 Ending the menu mode

Press the MENU button.

#### NOTE

- Make sure to end the menu mode when finished. If you fail to end the menu mode, several functions may not operate properly, including the Traffic Information function, the News Bulletin function with PTY news timeout setting, and the Alarm function.
- The News function turns on when the setting is made for the news interruption interval. The "##M" display indicates the setting selected for the news interruption timeout interval.

Function	Varieties of settings for each function (display)
Switching Clock Display	↓ CLK ON ↔ CLK OFF ↑↓
Time Adjustment (Manual) <When Automatic Time Adjustment is off>	CLK ADJ (Time Adjustment mode entered) ↑↓
Automatic Time Adjustment	SYNC ON ↔ SYNC OFF ↑↓
Disabled System Indicator	DSI ON ↔ DSI OFF ↑↓
Selectable Illumination	COL GRN ↔ COL AMB ↑↓
Switching Graphic Display	GRAP ON ↔ GRAP OFF ↑↓
Touch Sensor Tone	BEEP ON ↔ BEEP OFF ↑↓
Switching Preout	SWPRE F ↔ SWPRE NF ↑↓
News Bulletin Function	NEWS OFF ↔ NEWS ##M ↑↓
Local seek <In Tuner mode>	LO.S OFF ↔ LO.S ON ↑↓
Selecting Tuning Mode <In Tuner mode>	AUTO1 → AUTO2 → MANUAL ↑↓
Auto Memory Entry <In Tuner mode>	A-MEMORY (start) ↑↓
AF Function <Except in AM band>	AF ON ↔ AF OFF ↑↓
Region Restrict Function <Except in AM band>	REG ON ↔ REG OFF ↑↓
Auto TP Seek <Except in AM band>	ATPS ON ↔ ATPS OFF ↑↓
Monaural Reception <In FM reception of Tuner mode>	MONO OFF ↔ MONO ON ↑↓
Text/Title Scroll <In MD or CD changer mode>	SCL MANU ↔ SCL AUTO ↑

## Tuner features (See page 5)

### Selecting Tuning Mode

**You can choose from three tuning modes: auto seek, preset station seek, and manual. The **AUTO** indicator lights up when auto seek tuning is selected, and the **AUTO** indicator lights when preset station seek tuning is selected.**

- 1 Hold down the MENU button for one second or more. "MENU" is displayed and the menu mode is turned on.
- 2 Press the ►| button repeatedly until the tuning function appears in the display.  
Press the ◀| button to search in the other direction.  
The tuning method is displayed as "AUTO1", "AUTO2", or "MANUAL" referring respectively to auto seek tuning, preset station seek tuning, and manual tuning.
- 3 **Switching settings**  
Press either the AM button or FM button to switch the tuning mode.  
The display and setting will change.
- 4 Press the MENU button to end the menu mode.

### Tuning

- 1 Press the SRC button repeatedly until tuner mode is obtained. "TUNER" is displayed when the tuner mode has been selected.
- 2 Press either the FM or AM button to select the band. Each time you press the FM button, the band switches between the FM1, FM2 and FM3.  
Press the AM button to select the MW and LW bands.
- 3
  - Auto Seek Tuning  
Press the ►| button to seek increasing frequencies.  
Press the ◀| button to seek decreasing frequencies.
  - Preset station seek tuning  
Press the ►| button to move to the next preset station (i.e., the one with the next highest number), and the ◀| button to move to the last preset station (i.e., the one with the next lowest number).

#### NOTE

If the frequencies stored at the preset numbers receive stations which were not originally memorized when traveling long distances, the preset number is not displayed. In such cases, pressing the ◀|/►| button to use preset station seek will receive channel 1.

- Manual Tuning  
Press the ►| button to increase the frequency by one step.  
Press the ◀| button to decrease the frequency by one step.

#### NOTE

The ST indicator lights up when stereo broadcasts are being received.

## Local Seek Function

**With the local seek function turned on, auto seek tuning skips stations with relatively poor reception.**

### **Turning Local Seek Function On/Off:**

- 1 Hold down the MENU button for one second or more. "MENU" is displayed and the menu mode is turned on.
- 2 Press the ►► button repeatedly until the local seek function appears in the display. Press the ◀◀ button to search in the other direction. The function setting is indicated by "LO.S OFF" or "LO.S ON" in the display, indicating that the local seek function is on or off, respectively.
- 3 **Switching settings**  
Press either the AM button or FM button. The display and setting will change.
- 4 Press the MENU button to end the menu mode.

## Monaural Reception

**When poor stereo reception is experienced, this function will reduce noise and improve listening conditions.**

- 1 Hold down the MENU button for one second or more. "MENU" is displayed and the menu mode is turned on.
- 2 Press the ►► button repeatedly until the monaural reception function appears in the display. Press the ◀◀ button to search in the other direction. The function setting is indicated by "MONO OFF" or "MONO ON" in the display, indicating that monaural reception is on or off, respectively.
- 3 **Switching settings**  
Press either the AM button or FM button. The display and setting will change.
- 4 Press the MENU button to end the menu mode.

## Station Preset Memory

**Store the frequency of the station currently being listened to. You can then recall that station with a single touch of a button.**

- 1 Select the band/ station that you want to have stored.
- 2 Hold down the button (#1-6) that you want to use for the station, for two seconds or more. The button number blinks once in the display to indicate that the data has been stored.

### **Recalling a Preset Station:**

Press the preset station button (#1-6) for the desired station. The number of the recalled station is displayed.

#### **NOTE**

You can store 6 stations in each of the FM1, FM2, FM3, and AM (MW and LW) bands.

## Tuner features *(See page 5)*

### Auto Memory Entry

You can automatically store all the receivable frequencies in the band currently being listened to, and then recall them with the touch of a button later. This function is especially useful when you are travelling and do not know what stations are available. Up to 6 frequencies can be stored this way.

- 1 Select the band for auto memory entry.
- 2 Hold down the MENU button for one second or more. "MENU" is displayed and the menu mode is turned on.
- 3 Press the ►► button repeatedly until "A-MEMORY" appears in the display.  
Press the ◀◀ button to search in the other direction.
- 4 Hold down either the AM button or FM button for two seconds or more to start auto memory function.  
The numbers of the preset station buttons showed in order. When all the stations in a certain band are stored in the preset memory, the auto memory entry stops. The tuner then plays the last station received.

#### Recalling a Preset Station:

Press the preset station button (#1-6) for the desired station. The number of the recalled station is displayed.

#### NOTE

- When the AF function is turned on whilst auto memory entry takes place, only RDS stations (i.e., stations with RDS capability) are stored. RDS stations that have been preset for FM1 cannot also be preset in FM2 or FM3.
- When the local seek function is turned whilst auto memory entry takes place, stations with poor reception are not stored.
- When the Traffic Information function is on, only the local traffic information station frequency will be stored.

#### Canceling Auto Memory Entry During Its Operation:

Press the MENU button whilst auto memory entry is taking place to stop the process.

*Function of remote control with number/letter entry buttons  
(See page 7)*

### Direct Access Tuning

When you already know the frequency of the station that you want to listen to, you can enter it directly for quick access.

- 1 Select the band by pressing the FM or AM button.
- 2 Press the DIRECT button.  
The frequency part of the display blinks for 10 seconds. If you make no input in the 10-second period, direct access tuning is automatically cancelled.
- 3 Enter the frequency of the desired station whilst the display is blinking.  
If you want to listen to an FM station at 92.1 MHz, for example, press 0, 9, 2, and 1.  
If you want to listen to an AM station at 810 kHz, for example, press 0, 8, 1, and 0.

#### NOTE

- When a frequency which cannot be received is input, this frequency is not verified and operation returns to the original frequency input mode.
- FM frequencies can only be input in 0.1 MHz steps, and not in 0.01 steps.

#### Canceling Direct Access Tuning:

Press the DIRECT button again.

Function of remote control with DNPP button (See page 7)

### Preset station seek with Programme service name

**You can search for the preset station with Programme Service name.**

- 1 Press the DNPP button on the remote control. "SNP PLAY" will be displayed once the seek mode is entered. The names of the stations preset in the band currently listened to are displayed for 5 seconds each. The display band switches in the following order:

→ FM1 ↔ FM2 ↔ FM3 ↔ AM ←

Each time you press the ►► button, the station display switches in the forward direction.  
Each time you press the ◀◀ button, the station display switches in the reverse direction.  
Stations which have no names will be displayed as frequencies.

#### **NOTE** Changing the Displayed Band

Pressing the FM button switches between the FM1, FM2, FM3 and AM displays, in that order.  
Pressing the AM button switches between the displays in the reverse direction.

- 2 **Once the name is displayed for the station you want to listen to**

Press the OK button.  
Reception starts of the displayed station, and the seek mode ends.

#### **Cancelling mode during input:**

Press the DNPP button.  
The seek mode is cancelled.

### Switching Display for Tuner (non-RDS station)

#### **Switching the Display:**

Each time you press the DISP button, the display switches between the frequency and Clock.

#### **NOTE**

- When the switching clock display (see p.30) is set to off, the display will not switch to the clock display.
- The ● indicator lights whilst the clock is displayed.

## RDS features (See page 6)

### RDS (Radio Data System)

RDS is a digital information system that lets you receive signals besides those of regular radio programmes, such as network information being transmitted from radio stations. When listening to an RDS station (ie, a station with RDS capability), the programme service name of the station is displayed along with the frequency, advising you quickly which station is being received.

RDS (Radio Data System) stations also transmit frequency data for the same station. When you are making long trips, this function automatically switches to the particular frequency with the best reception for the particular network of stations that you want to listen to. The data is automatically stored, allowing you to switch quickly to another RDS stations, broadcasting the same programme, that has better reception. These include stations stored in the station preset memory that you often listen to.

### EON (Enhanced Other Network)

Stations that offer EON also transmit information about other RDS stations that have traffic information. When you are tuned to a station that is not transmitting traffic information, but another RDS station starts transmitting a traffic bulletin, the tuner automatically switches to the other station for the duration of the bulletin.

### Alarm

When an emergency transmission (announcing disasters, etc.) is sent, all current functions are interrupted to allow the warning to be received.

### AF (Alternative Frequency) Function

When poor reception is experienced, automatically switch to another frequency broadcasting the same programme in the same RDS network with better reception.

The **AF** indicator lights up when the AF function is turned on.

#### Turning AF Function On/Off:

- 1 Hold down the MENU button for one second or more. "MENU" is displayed and the menu mode is turned on.
- 2 Press the **▶▶** button repeatedly until the AF function appears in the display. Press the **◀◀** button to search in the other direction. The function setting is indicated by "AF ON" or "AF OFF" in the display, indicating that the AF function is on or off, respectively.
- 3 **Switching settings**  
Press either the AM button or FM button. The display and setting will change.
- 4 Press the MENU button to end the menu mode.

#### Displaying Frequencies:

- When the Switching Clock display function (see p.30) is OFF: Press the DISP button.
- When the Switching Clock display function (see p.30) is ON: Hold down the DISP button for one second or more. The frequency for the RDS station will be displayed for five seconds instead of the station name.

#### NOTE

When no other stations with stronger reception are available for the same programme in the RDS network, you may hear the incoming broadcast in bits and snatches. Turn off the AF function in such a case.

## Restricting RDS Region (Region Restrict Function)

You can choose whether or not to restrict the RDS channels, received with the AF function for a particular network, to a specific region. When the Region Restrict Function is on, the region is restricted and the REG indicator is turned on.

### Turning Region Restrict Function On/Off:

- 1 Hold down the MENU button for one second or more. "MENU" is displayed and the menu mode is turned on.
- 2 Press the ►► button repeatedly until the Region restrict function appears in the display. Press the ◄◄ button to search in the other direction. The function setting is indicated by "REG ON" or "REG OFF" in the display, indicating that the function is on or off, respectively.
- 3 **Switching settings**  
Press either the AM button or FM button. The display and setting will change.
- 4 Press the MENU button to end the menu mode.

#### NOTE

Sometimes stations in the same network broadcast different programmes or use different programme service names.

## Traffic Information Function

You can listen to traffic information. If you are listening to tapes or discs, they will continue playing until a traffic bulletin is broadcast.

### Turning TI function On/Off:

Press the TI button to turn the function on and off. When the function is on, the TI indicator is turned on. When a traffic information station is being received, the TP indicator will turn on. When none is being received, the TI indicator will blink on and off. When a traffic bulletin begins to be broadcast, the TA indicator will turn on, and reception will begin at the preset volume. If you are listening to a tape or disc when a traffic bulletin begins, they will automatically be turned off. When the bulletin ends or poor reception is experienced, the tape or disc will begin playing again.

#### NOTE

Pressing the TI button whilst in the MW/LW band automatically switches reception to the FM band. However, the MW/LW band is not returned to when the TI button is pressed again.

### Switching to a Different Traffic Information Station:

Use the ◄◄ / ►► buttons to make an auto seek of the TI stations in a certain band.

#### NOTE

- When you are listening to a tape or disc, you cannot change to another TI station.
- When the auto TP seek function is turned on and reception starts to weaken, the tuner automatically seeks stations with better reception.
- If you are tuned to a station that is not a traffic information station itself but which provides EON services, you can still have traffic information received.
- Holding the TI button down for one second or more when the TI function is on in the disc control mode results in a change to the frequency display of the traffic information station for five seconds.

## RDS features (See page 6)

### Auto TP Seek Function

When the TI function is on and poor reception conditions are experienced when listening to a traffic information station, another traffic information station with better reception will be searched for automatically. This function is on, when unit is first powered on.

#### Turning Auto TP Seek Function On/Off:

- 1 Hold down the MENU button for one second or more. "MENU" is displayed and the menu mode is turned on.
- 2 Press the ►| button repeatedly until the Auto TP Seek function appears in the display. Press the |◀ button to search in the other direction. The function setting is indicated by "ATPS ON" or "ATPS OFF" in the display, indicating that the function is on or off, respectively.
- 3 **Switching settings**  
Press either the AM button or FM button. The display and setting will change. If the traffic information station you are tuned to experiences poor reception, this function automatically seeks another TP station.
- 4 Press the MENU button to end the menu mode.

### Presetting Volume for Traffic Information/News

Preset the volume level to be used for traffic information and news broadcasts.

- 1 Tune into the station for which you want to set the volume.
- 2 Adjust the volume to the desired level.
- 3 Hold down the VOL ADJ button for two seconds or more. The volume level blinks once in the display to indicate that the data has been stored. Future traffic information/news broadcasts are heard at the preset level.

#### NOTE

- The volume cannot be lowered by this function during tuner reception. The volume is only set when it is louder than the listening volume of the tuner.
- You can arrange only to listen to traffic information or news bulletins with at preset volume with the volume set at minimum.



## News Bulletin Function with PTY News Timeout Setting

**You can arrange to have news bulletins interrupt your current listening source, including other radio stations. When the News Bulletin function is on, the PTY News Timeout setting allows you to set the interval during which further news interruption cannot take place. You can adjust the PTY news interruption period from 10 to 90 minutes for each journey.**

### Turning News Bulletin Function On/Off:

- 1 Hold down the MENU button for one second or more. "MENU" is displayed and the menu mode is turned on.
- 2 Press the ►► button repeatedly until the News Bulletin function appears in the display.  
Press the ◀◀ button to search in the other direction.  
The function setting is indicated by "NEWS OFF" or "NEWS ##M" in the display, indicating that the function is on or off, respectively.

#### NOTE

Depending on the interval chosen, the "##M" in the display will change when the function is turned on.

### 3 Changing the Function Setting

Press either the FM or AM button.

Each time you press the FM or AM button until the desired setting is displayed.

Press the FM button to increase the interval, and the AM button to decrease it.

OFF ↔ 00M ↔ 10M ↔ 20M ↔ 30M ↔ 40M ↔ 50M ↔ 60M  
↔ 70M ↔ 80M ↔ 90M (M= minutes)

When you select the news interruption timeout interval, the News function turns on and the NEWS indicator lights up.

When a news bulletin is received, the NEWS indicator will blink and reception will begin at the preset volume.

#### NOTE

If you choose the "20M" setting, further news bulletins will not be received for 20 minutes once the first news bulletin is received. Setting the interval at the "00M" factory default indicates no News Timeout will be made, meaning that additional news

bulletins will continue to be searched for.

- 4 Press the MENU button to end the menu mode.

#### NOTE

- This function is only available if the desired station sends PTY-code for news bulletin or belongs to EON-Network sending PTY-code for news bulletin.
- If you turn on the news bulletin function in the MW/LW band, the band is switched automatically to the FM band. However, the MW/LW band is not returned to when you turn off the function.

## RDS features (See page 6)

### Programme Type (PTY) Function

**Conduct auto seek tuning only on those stations with selected kinds of programmes.**

- 1 Press the ►|| (PTY) button.  
“PTY” is displayed, and the Programme Type Selection (PTY) Mode entered.  
If you make no key input in 30 seconds, the mode will automatically turn off.

#### NOTE

You cannot use this function whilst the traffic information function is turned on.

#### NOTE

Changing the Display Language to French or German  
In the PTY mode, hold down the ►|| (PTY) button for one second or more to display the name of the language currently used.  
If you want to change the language, press the preset button for the desired language and then the ►|| (PTY) button.  
English is #1, French is #2, and German is #3.

### 2 Select the type of programme to be received

- Press either the FM or AM buttons repeatedly to select the type of programme you want to listen to.

The selection includes:

Speech(SPEECH) ↔ 1.News(NEWS) ↔ 2.Current Affairs(AFFAIRS) ↔ 3.Information(INFO) ↔ 4.Sports(SPORT) ↔ 5.Education(EDUCATE) ↔ 6.Drama(DRAMA) ↔ 7.Culture(CULTURE) ↔ 8.Science(SCIENCE) ↔ 9.Varied(VARIED) ↔ 10.Pop Music(POP M) ↔ 11.Rock Music(ROCK M) ↔ 12.M,O,R Music(M.O.R. M) ↔ 13.Light Classical(LIGHT M) ↔ 14.Serious Classical(CLASSICS) ↔ 15.Other Music(OTHER M) ↔ 16.Weather(WEATHER) ↔ 17.Finance(FINANCE) ↔ 18.Children’s programmes(CHILDREN) ↔ 19.Social Affairs(SOCIAL A) ↔ 20.Religion(RELIGION) ↔ 21.Phone In(PHONE IN) ↔ 22.Travel(TRAVEL) ↔ 23.Leisure(LEISURE) ↔ 24.Jazz Music(JAZZ) ↔ 25.Country Music(COUNTRY) ↔ 26.National Music(NATION M) ↔ 27.Oldies Music(OLDIES) ↔ 28.Folk Music(FOLK M) ↔ 29.Documentary(DOCUMENT) ↔ Music(MUSIC) ↔ Speech(SPEECH)↔

(Speech.....1~9,16~23, 29, Music.....10~15, 24~28)

- You can select the type of programme directly by pressing a preset button. The buttons are factory-set to the following type of programmes:
 

1. Music	2. Speech	3. News
4. Other Music	5. Serious Classical	6. Varied

#### NOTE

**Changing the Preset Button Settings for Programme Type**  
After selecting the type of programme to be stored in a certain preset button, hold down that button for two seconds or more. The previously stored data for that button are erased and the new programme type is stored.

### 3 Seeking the selected programme type

Press the ◀◀ or ▶▶ button to make a seek of frequencies with your selected type of programme.

The display blinks and the seek starts.

If your selected type of programme is found, the name of the station is displayed and the station is tuned into.

“PTY” blinks in the display for about 30 seconds.

If you make no key input in 30 seconds, the PTY selection mode will turn off automatically.

#### NOTE

If no programme can be found, "NO PTY" is displayed.

If you want to select another type of programme, repeat steps 2 and 3 above.

### Switching to Other Stations with the Same Type of Programme:

When “PTY” is blinking in the display, perform auto seek tuning.

The tuner scans for another station with the same type of programme.

### Cancelling Programme Type Function During Its Operation:

Press the ►|| (PTY) button.

## Disc control features *(See page 6)*

### Playing MDs

#### Playing MDs:

A press of the release button causes the faceplate to drop to the front, thereby exposing the MD slot. Insert the MD in the proper orientation. The MD will start playing. Push back on the right side of the faceplate with your hand until it locks.

The **• IN •** indicator will light when an MD has been inserted.

#### ▲CAUTION

When inserting an MD, make sure the MD has been completely drawn in before pushing back the faceplate. Failing to do so might deform the MD.

#### Playing MDs Already Inserted:

Press the SRC button repeatedly until the MD mode is obtained.

"MD" is displayed when the MD mode has been selected.

The MD will start playing.

#### Pausing and Restarting MD Play:

Press the **▶||** button to make the disc pause.

Press the same button again to start play again.

#### Eject:

Press the release button and drop open the faceplate.

Press the **▲** button located near the MD slot.

The MD stops playing and ejects from the slot.

Push back on the right side of the faceplate with your hand until it locks.

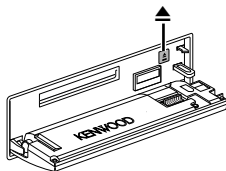

#### ▲CAUTION

- When the faceplate has been dropped open, it might interfere with the shift lever or something else. If this happens, pay attention to safety and move the shift lever or take an appropriate action, then operate the unit.
- Do not apply excessive force to the open faceplate or place objects on it. Doing so will cause damage or breakdown.

- Do not use the unit with the faceplate in the open condition. Doing so will cause breakdown.

## Disc control features *(See page 6)*

- When a unit equipped with an O-N switch is to be connected, please also see the instruction manual of this unit. Set the O-N switch to "N". "N"-operation will be set.
- When a unit that is not equipped with an O-N switch, or the changer switching unit "KCA-S200" is connected, "O"-operation will be set.

### "N"-operation:

- The disc title and track title of the CD text can be displayed.
- The disc name will be displayed when the name has been registered to any connected unit with the Presetting Disc Names function, or when the playing unit contains a disc to which the disc title has been recorded.

### "O"-operation:

- CD text cannot be displayed.
- Regardless of the control unit, the characters that can be registered with the Presetting Disc Names function are "A~Z 0~9 /, +, -, \*, =, <, >, |, !".
- The disc name will be displayed when the name has been registered to the playing unit with the Presetting Disc Names function.

#### NOTE

The CD text, Presetting Disc Names, and Disc Name Preset Play functions may not be operational depending on the unit.

## Playing Other Disc mode

This function permits the connection of optional players and the playing of discs other than the loaded MD (in the current unit).

### Playing Discs:

Press the SRC button repeatedly until the disc control mode is obtained.

The disc will start playing.

#### NOTE

The disc control mode will differ, depending on the unit that is connected.

Mode Display Examples)

- "DISC"...when a disc changer is connected
- "DISC-1", "DISC-2"...when two disc changers are connected

### Pausing and Restarting Disc Play:

Press the ►|| button to make the disc pause.

Press the same button again to start play again.

#### NOTE

- When one disc has finished playing its last track, the next disc in the changer starts playing. When the last disc in the changer has finished, the player returns to the first disc and starts playing it.
- Disc #10 is displayed as "0".

## Fast Forwarding and Reversing Disc Play

### Fast Forwarding Disc Play:

Hold down on the ►► button.

Release your finger to play the disc at that point.

### Reversing Disc Play:

Hold down on the ◀◀ button.

Release your finger to play the disc at the point.

#### NOTE

You cannot use reverse play between tracks depending on the model being connected. Instead, the reverse play function is cancelled when it reaches the beginning of a track, at which point normal play automatically resumes.

## Track Search

### Search forwards or backwards through the tracks on the disc until you reach the one that you want to listen to.

#### Making a Reverse Track Search:

Press the ◀◀ button to display the desired track number.

Press once to search back to the beginning of the current track, twice to search back to the beginning of the previous track, and so forth.

Play starts at the beginning of the displayed track number.

#### NOTE (for disc changers)

Pressing the ◀◀ button whilst listening to track 1 only searches back to the beginning of that track. The reverse search is not "recycled" to the last track on the disc.

#### Making a Forward Track Search:

Press the ►► button to display the desired track number.

Press once to fast forward to the next track, twice to fast forward to the track after that, and so forth.

Play starts at the beginning of the displayed track number.

#### NOTE (for disc changers)

You cannot make a forward track search when listening to the last track on a disc.

## Disc Search

### Search forwards or backwards through the discs in a disc changer until you reach the one that you want to listen to.

#### Making a Reverse Disc Search:

Press the DISC- button to display the desired disc number.

Each time the button is pressed, the displayed disc number decreases by one.

Play starts at the beginning of the displayed disc.

#### Making a Forward Disc Search:

Press the DISC+ button to display the desired disc number.

Each time the button is pressed, the displayed disc number increases by one.

Play starts at the beginning of the displayed disc.

#### NOTE

"LOAD" is displayed when discs are being exchanged on the disc changer.

## Disc control features *(See page 6)*

### Function of disc changers

#### Track / Disc Repeat Function

Repeat playing the current track or disc.

##### Turning Repeat Play Function On/Off:

Press the REP button to switch the repeat play function on and off as follows :

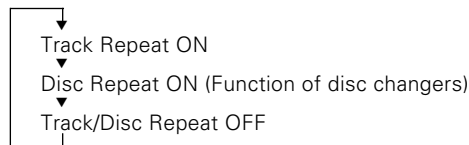

The track number blinks in the display when the track repeat function is on.

The disc number blinks in the display when the disc repeat function is on.

##### NOTE

The repeat play function is cancelled when you stop playing the disc.

#### Track Scan Function

Successively play the beginning of each track on a disc until you find the track that you want to listen to.

##### Turning Track Scan Function On/Off:

Press the SCAN button to switch the track scan function on and off.

The first 10 seconds of each track are played, and the tracks are played in order.

The track number currently being heard blinks in the display.

##### Stopping to Listen to the Track Being Scanned:

Press the ►|| or SCAN button again to stop the scan and keep on listening to a track normally.

##### NOTE

- The track scan function is cancelled when you stop playing a disc.
- The track scan function only scans each track on a disc once.

#### Disc Scan Function

Successively play the beginning of each disc on a changer until you find the one that you want to listen to.

##### Turning Disc Scan Function On/Off:

Press the D.SCN button to switch the disc scan function on and off.

The first 10 seconds of each disc are played, in the order in which they are loaded on the changer.

The disc number currently being heard blinks in the display.

##### Stopping to Listen to the Disc Being Scanned:

Press the ►|| or D.SCN button again to stop the scan and keep on listening to the disc normally.

##### NOTE

- The disc scan function is cancelled when you stop playing a disc.
- The disc scan function only scans each disc on the changer once.
- "LOAD" is displayed when discs are being exchanged on the disc changer.

## Random Play Function

**Play all the tracks on the current disc in random order.**

- 1 Press the RDM button to switch the random play function on and off.  
The display of the track number changes continuously as the next track is being selected.  
When the track has been selected, play starts.  
The selected track number blinks in the display as it is being played.

### NOTE

When all the tracks on a certain disc have been played using the random play function, the next disc on the changer starts playing (with the random play function still turned on).

- 2 To change the track being heard, press the ►►I button.  
Another track is selected and played.

### NOTE

The random play function is cancelled when you stop playing a disc.

## Function of disc changers

### Magazine Random Play Function

**Play the tracks on all the discs in the disc changer in random order.**

- 1 Press the M.RDM button to switch the magazine random play function on and off.  
The display of the disc and track numbers change continuously as the next track is being selected.  
When the disc/track has been selected, play starts.  
The selected disc/track number blinks in the display as it is being played.

### NOTE

This function is not available with the following models:  
KDC-C200/C300/C400/C301/C401

- 2 To change the track being heard, press the ►►I button.  
Another disc/track is selected and played.

### NOTE

- The magazine random play function is cancelled when you stop playing a disc.
- The time needed for random selection depends on the number of discs loaded in the disc magazine.

## Disc control features *(See page 6)*

### Switching Display for Discs

Switch the display that appears whilst discs are playing.

#### Switching Display for Discs:

Each time you press the DISP button, the display during disc play switches as follows.

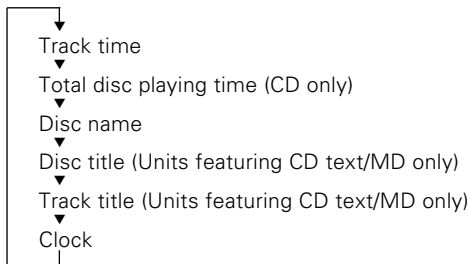

#### NOTE

- You can give names to discs through the presetting disc name function (see p.26).  
Note that depending on the unit, display may not be possible.
- If you try to display the name of a disc that does not have one, "NO NAME" is displayed instead.
- Only when the Switching Clock display function (see p.30) is on, the clock is displayed.
- When an attempt is made to display the title of a disc for which a disc title/track title has not been recorded, the CD will display "NO TEXT", the MD player built into this unit will display "NO TITLE", and an MD changer will display "NO NAME".
- Depending on the type of characters of the CD Text, some characters may not be displayable.

### Text / Title Scroll

This function permits the text to be scrolled and the entire text to be displayed. Switching between manual scrolling and automatic scrolling is permitted. The factory default is manual scrolling.

#### To scroll manually:

- 1 Press the DISP button to display the disc title or the track title.
- 2 Holding down the DISP button for one second or more results in one scrolling display of the titles.

#### Manual/Automatic scroll switching:

- 1 Hold down the MENU button for one second or more. "MENU" is displayed and the menu mode is turned on.
- 2 Press the ►► button repeatedly to switch the function to be set to the text scroll function. Pressing the ◀◀ button results in the functions being switched in the reverse order. The text scroll function is displayed with "SCL MANU" or "SCL AUTO".  
"SCL MANU" (Manual scrolling)  
"SCL AUTO" (Automatic scrolling)
- 3 **Switching settings**  
Press either the AM button or FM button.  
The display and setting will change.
- 4 Press the MENU button to end the menu mode.

#### To scroll automatically:

- 1 Press the DISP button to display the disc title or the track title. The titles will be displayed in one scrolling display.

#### NOTE

When the disc or track to be played changes, the title is displayed in one scrolling display.

- 2 Holding down the DISP button for one second or more results in one scrolling display of the titles.

#### NOTE

- Only units with a CD text feature permit title display.
- This function is not supported for MD changers.



*Function of remote control with number/letter entry buttons  
(See page 7)*

### **Direct Track Search**

**Using the remote control, make direct input of the track number that you want to listen to.**

- 1 Using the numeric buttons on the remote control, enter the number of the track that you want to listen to.  
The selected track number blinks in the display for 10 seconds. If you make no further input in the 10-second period, the number entry mode will automatically be cancelled.
- 2 Press either the TRACK+ or TRACK- button whilst the track number is blinking.  
The track specified in step 1 starts playing.

***Cancelling Direct Track Search During Its Operation:***

Press the ►|| button.

**NOTE**

You cannot use the direct track search function whilst doing track or disc scans or using random or magazine-random play.

*Function of disc changers with remote control having  
number/letter entry buttons (See page 7)*

### **Direct Disc Search**

**Using the remote control, make direct input of the disc number that you want to listen to.**

- 1 Using the numeric buttons on the remote control, enter the number of the disc that you want to listen to.  
The selected disc number blinks in the display for 10 seconds. If you make no further input in the 10-second period, the number entry mode will automatically be cancelled.

**NOTE**

- Input "0" to select disc #10.
  - If you enter more than two numbers all at once, a search will be made only of the last number entered.
- 2 Press either the DISC+ or DISC- button whilst the number inputted is blinking.  
The disc specified in step 1 starts playing.

***Cancelling Direct Disc Search During Its Operation:***

Press the ►|| button.

## Disc control features (See page 6)

### Presetting Disc Names

#### Store the names of discs to be displayed when played.

- 1 Play the disc whose name you want to preset.

#### NOTE

- This function cannot be used with the MD built into this unit nor with disc changers that do not have a Disc Name Preset function.
- This procedure is not to be used to store the disc and track titles for MDs that you record.

- 2 Hold down the NAME.S button for two seconds or more. "NAME SET" is displayed and the disc name preset mode is entered. The cursor blinks in the position where character input can be made.

- 3 Press either the ◀◀ or ▶▶ button to move the cursor to the desired position. The ◀◀ button moves the cursor to the left, and the ▶▶ button to the right. You can also move the cursor left or right by pressing the TRACK+ or TRACK- buttons, respectively, on the remote control.

- 4 Each time the ▶|| button is pressed, the characters to be entered change as listed below. Press the DISC+ or DISC- button to display the desired character. Characters that can be displayed are as follows. Alphabet (capital letters) : A~Z  
Numerals/characters : 1~9 0 @ " ' ` % & \* + - = , . / \ < > [ ]

#### NOTE

The operation and characters that can be entered may change as listed below, depending on the unit that is connected. A press of the ▶|| button exits the disc name preset mode. Operations can be followed again from Step 2 at a time such as this, and the characters to be input are selected using the procedure described below. Press the DISC+ or DISC- button to display the desired character. Besides the alphabet (capital letters only) and numbers, you can choose the following characters: /, +, -, \*,

=, <, >, [ and ].

#### NOTE Direct Alphabet Input

If the disc changers that were manufactured and sold after 1997 are connected, you can directly input letters using the number/letter entry buttons on the remote control.

Example: Use the following table to enter the name "DANCE".

Character	Button to press	# Times pressed
"D"	#3	1
"A"	#2	1
"N"	#6	2
"C"	#2	3
"E"	#3	2

- 5 Continue steps 3 and 4 until all the characters are chosen for the name.

#### NOTE

You can enter up to 8 characters for each name.

- 6 Press either the NAME.S button on the main unit or the OK button on the remote control. The disc name is stored and the disc name preset mode is cancelled. If you make no entry in a 10-second period, the name will be stored with the characters entered so far.

#### NOTE

- The number of discs whose names can be stored will differ depending on the disc changer that is connected. Please see your disc changer manual for details.
- Discs are identified by their total length and number of tracks. If another disc happens to have the same specifications as one that you have already stored a name for, the name will be displayed for it too.
- If you want to change the name of a disc, repeat steps 1 and 2 to display the name, and then repeat steps 3 and 4 to enter the changes.
- Pressing the reset button does not erase the names stored in a disc changer.

## Disc Name Preset Play (DNPP)

**If you have preset the name of a disc that you want to listen to in the disc changer, you can look for it by name and start playing it.**

- 1 Press the DNPP button on the remote control.  
"DNP PLAY" will appear in the display, and the disc name preset play mode is entered.  
The preset names/disc titles of the disc in the disc changer to which you are currently listening are successively displayed for five seconds each.  
In any of the units that are connected, discs that have not been disc name preset will display "NO NAME".

### NOTE

- This function can only be used in CD changers that were manufactured or sold as of 1997. Also note that some units cannot provide a display unless the disc name preset has been made by the unit that is playing.
- Discs in the disc changer that have never been played before will appear as "NO ACCES" when the disc names are displayed. When you cannot identify a disc because of the "NO ACCES" display after inserting a disc magazine, try playing it using the disc scan or a similar function to display the disc name. Also note that "NO DISC" will be displayed when a disc has not been loaded.

### **Rapid display (forward / reverse):**

Press the DISC+ or DISC- button.  
Pressing the DISC+ button will rapidly display the preset names/disc titles in order.  
Pressing the DISC- button will rapidly display the preset names/disc titles in reverse order.

### **2 When the name appears for the disc you want to play**

Press the OK button.  
The disc whose name is displayed will be recalled, and the disc name preset play (DNPP) mode will end.

### **To cancel DNPP mode:**

Press the DNPP button.  
The disc name preset play (DNPP) mode will be cancelled.

## Other features *(See page 7)*

### Audio Control Setting

#### Adjust various parameters of sound quality.

- 1 Press the AUDIO button to enter the control mode.
- 2 Press either the FM or AM button.  
Each time the button is pressed, the adjustment mode will change as follows:  
Pressing the FM button advances the display, and pressing the AM button reverses it.

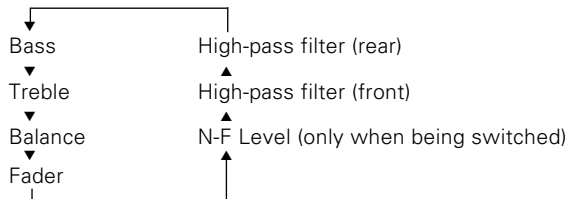

#### **NOTE** Source tone memory

Each source (MD, FM, AM, and disc changer) has its own memory in which to store the bass and treble tone settings. The settings made for a particular source are then recalled automatically whenever you use that source (e.g., FM mode uses the tone settings made for FM, AM for AM, etc.).

- 3 Press the ◀▶ button.  
Look at the table to adjust the mode being displayed.
- 4 Press the AUDIO button to end the control mode.

#### **NOTE** Setting the high-pass filter

You can separately set the high-pass filter for front and rear output, including preouts. The high-pass filter works except during non-fading preout when switching to non-fading. The factory default settings for front output and rear output are "through".

### Table of Audio Control Setting

Adjustment mode (Display)	Operation of Audio control button	
	◀▶ button	▶▶ button
Bass ("BAS")	Bass decreased.	Bass increased.
Treble ("TRE")	Treble decreased.	Treble increased.
Balance ("BAL")	Left channel emphasized.	Right channel emphasized.
Fader ("FAD")	Rear channel increased.	Front channel increased.
Non-Fading Preout Level ("NF")	The front and rear sound is emphasized.	The non-fading sound is emphasized.
High-pass filter for front output ("HP F")	You can select the frequency to be cut, as follows: THROU (through) ↔ 40Hz ↔ 60Hz ↔ 80Hz ↔ 100Hz ↔ 120Hz ↔ 150Hz ↔ 180Hz ↔ 220Hz	
High-pass filter for rear output ("HP R")	You can select the frequency to be cut, as follows: THROU (through) ↔ 40Hz ↔ 60Hz ↔ 80Hz ↔ 100Hz ↔ 120Hz ↔ 150Hz ↔ 180Hz ↔ 220Hz	

## Switching Preout

**Switch the preout between the front and non-fading. When you switch to non-fading, you can adjust the volume separately. The factory default is front preout.**

### Switching the preout:

- 1 Hold down the MENU button for one second or more. "MENU" is displayed and the menu mode is turned on.
- 2 Press the ►► button repeatedly until the Switching preout function appears in the display. Press the ◀◀ button to search in the other direction. The function setting is indicated by "SWPRE F" or "SWPRE NF" in the display, indicating that the current preout is front or non-fading, respectively.  
"SWPRE F" (Front preout)  
"SWPRE NF" (Non-fading preout)
- 3 **Switching settings**  
Press either the AM or FM button. The display and setting will change.
- 4 Press the MENU button to end the menu mode.

#### NOTE

You cannot use the high-pass filter with non-fading preout.

### Turning non-fading output On/Off :

Hold down the NF button for one second or more to set the function ON or OFF.

"NF ON" is displayed when the non-fading output is set ON.

## TEL Mute Function

**Shut down the audio system temporarily whenever an incoming call is received.**

#### NOTE

The function will not work if a cable is not connected to the car phone.

### When the telephone rings:

When a call is received, "CALL" is displayed and all the unit functions are temporarily interrupted.

### Restoring Original Unit Source During Phone Call:

Press the SRC button.

"CALL" disappears from the display, and the volume of the original source is restored gradually.

### Turning TEL Mute Function Off After Phone Call:

Hang the phone up.

"CALL" disappears from the display.

The original source (i.e., the one used before the phone call) is returned to automatically, and the volume restored gradually.

## Navigation Mute Function

**When the KENWOOD Navigation System is connected, an interruption of the audio guide results in the temporary lowering of the audio level.**

#### NOTE

The Navigation mute function cannot be used unless a TEL mute cable is connected to the KENWOOD Navigation System.

## Other features *(See page 7)*

### Selectable Illumination

You can switch the colour of the button illumination between green and amber.

- 1 Hold down the MENU button for one second or more. "MENU" is displayed and the menu mode is turned on.
- 2 Press the ►► button repeatedly until the Selectable Illumination function appears in the display. Press the ◄◄ button to search in the other direction. The function setting is indicated by "COL GRN" or "COL AMB" in the display, indicating that the current colour is green or amber, respectively.
- 3 **Switching settings**  
Press either the AM button or FM button. The display and setting will change.
- 4 Press the MENU button to end the menu mode.

### Automatic Dimmer Function

The display dims when the car's lights are turned on.

#### NOTE

The dimmer function is not available for units if the dimmer cable is not connected.

### Switching Clock Display

This function permits switching the clock display on/off when switching the display during each of the modes.

#### Turning the Clock Display On/Off:

- 1 Hold down the MENU button for one second or more. "MENU" is displayed and the menu mode is turned on.
- 2 Press the ►► button repeatedly until the Switching Clock Display function appears in the display. Press the ◄◄ button to search in the other direction. The function setting is indicated by "CLK ON" or "CLK OFF" in the display, indicating that the Clock Display function is on or off, respectively.
- 3 **Switching settings**  
Press either the AM button or FM button. The display and setting will change.
- 4 Press the MENU button to end the menu mode.

### Touch Sensor Tone

This function produces a beep sound that accompanies button operation. It can be switched on or off.

#### Switching the Beep On/Off:

- 1 Hold down the MENU button for one second or more. "MENU" is displayed and the menu mode is turned on.
- 2 Press the ►► button repeatedly until the Touch Sensor Tone function appears in the display. Press the ◄◄ button to search in the other direction. The function setting is indicated by "BEEP ON" or "BEEP OFF" in the display, indicating that the current beep setting is on or off, respectively.
- 3 **Switching settings**  
Press either the AM button or FM button. The display and setting will change.
- 4 Press the MENU button to end the menu mode.

#### NOTE

The beep sound is not output from the preout jacks.

## Switching Graphic Display

This function permits the graphic display to be switched to one that is linked with the volume level value or to display various modes. The initial setting is ON (displaying various modes).

### Turning the Graphic Display On/Off:

- 1 Hold down the MENU button for one second or more. "MENU" is displayed and the menu mode is turned on.
- 2 Press the ►►| button repeatedly until the Switching Graphic Display function appears in the display. Press the ◀◀| button to search in the other direction. The function setting is indicated by "GRAP ON" or "GRAP OFF" in the display, indicating that the Graphic display is on or off, respectively.  
"GRAP ON" (Displays various modes)  
"GRAP OFF" (Display linked to the volume level value)
- 3 **Switching settings**  
Press either the AM button or FM button. The display and setting will change.
- 4 Press the MENU button to end the menu mode.

#### NOTE

When making audio adjustments, even when this function is on, the display will be linked to the audio adjustment value, not the display of the various modes.

## DSI (Disabled System Indicator)

A red indicator blinks on the unit after the faceplate is removed, warning potential thieves. The factory default for this function is "ON".

### Turning Disabled System Indicator On/Off:

- 1 Hold down the MENU button for one second or more. "MENU" is displayed and the menu mode is turned on.
- 2 Press the ►►| button repeatedly until the Disabled System Indicator function appears in the display. Press the ◀◀| button to search in the other direction. The function setting is indicated by "DSI ON" or "DSI OFF" in the display, indicating that the disable system indicator is on or off, respectively.
- 3 **Switching settings**  
Press either the AM button or FM button. The display and setting will change.
- 4 Press the MENU button to end the menu mode.

## Other features *(See page 7)*

### Adjusting Time

**With automatic time adjustment, you can set the clock time automatically according to time data sent from RDS stations (after receiving RDS signals for several minutes). You can also set the time manually if the automatic time adjustment function is turned off. The factory default is automatic time adjustment.**

#### **Adjusting Time Automatically:**

Tune into an RDS station for 3 or 4 minutes.

The time adjusts automatically to the correct local time.

#### **NOTE**

The time is not adjusted when the RDS station you are tuned to is not transmitting a time signal. Choose another RDS station in such a case.

#### **Turning Automatic Time Adjustment On/Off:**

- 1** Hold down the MENU button for one second or more. "MENU" is displayed and the menu mode is turned on.
- 2** Press the ►► button repeatedly until the Automatic Time Adjustment function appears in the display. Press the ◀◀ button to search in the other direction. The function setting is indicated by "SYNC ON" or "SYNC OFF" in the display, indicating that the Automatic Time Adjustment is on or off, respectively.  
"SYNC ON" (Automatic time adjustment)  
"SYNC OFF" (Manual time adjustment)
- 3** **Switching settings**  
Press either the AM button or FM button. The display and setting will change.
- 4** Press the MENU button to end the menu mode.

#### **Adjusting Time Manually:**

- 1** Turn off the Automatic Time Adjustment as mentioned above.
- 2** Hold down the MENU button for one second or more. "MENU" is displayed and the menu mode is turned on.

- 3** Press the ►► button repeatedly until the "CLK ADJ" appears in the display.  
Press the ◀◀ button to search in the other direction.
- 4** Hold down either the AM or FM button for two seconds or more to enter the Time Adjustment mode. The hour display will blink.
- 5**
  - Adjusting the hours  
Press the FM button to advance the hours, or press the AM button to make the hours go back.
  - Adjusting the minutes  
Press the ►► button to advance the minutes, or press the ◀◀ button to make the minutes go back.
- 6** Press the MENU button to end the menu mode.



## Theft Deterrent Faceplate

The faceplate of the unit can be detached and taken with you, helping to deter theft.

### Removing Faceplate:

Press the release button and drop open the faceplate.

In its dropped condition, while drawing the faceplate to one side, pull it to the front and remove it.

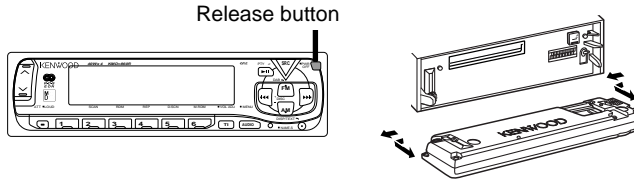

### NOTE

- The faceplate is a precision piece of equipment and can be damaged by shocks or jolts. For that reason, keep the faceplate in its special storage case whilst detached.
- Do not expose the faceplate or its storage case to direct sunlight or excessive heat or humidity. Also avoid places with too much dust or the possibility of water splashing.

### Reattaching Faceplate:

Hold the faceplate so that the operation face faces the front toward you and press until it locks. The faceplate will be set and the unit will be operational.

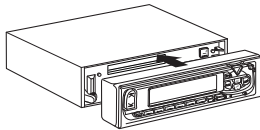

### NOTE

When there is difficulty in setting the faceplate, align the depression on the left side of the faceplate with the shaft of the unit, then lock.

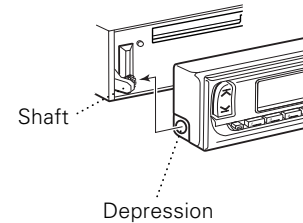

## Basic operations of remote control *(See page 7)*

Optional

### ⚠ CAUTION

Do not set the remote control on hot places such as above the fascia panel (dashboard).

### Replacing the Lithium Battery:

Use one lithium battery (CR2025).

Remove the case following the instructions as illustrated.

To open

① Keep on slide.

② Pull out.

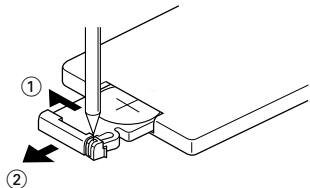

Insert the battery with the  $+$  and  $-$  poles aligned properly, following the illustration inside the case.

### ⚠ WARNING

Store unused lithium batteries out of the reach of children. Contact a doctor immediately if the battery is accidentally swallowed.

### NOTE

A portion of the operations may not be possible, depending on the unit that is connected.

### All Modes

- **VOL. buttons**  
Keep on pressing the  $\wedge$  button to turn the volume up.  
Keep on pressing the  $\vee$  button to turn the volume down.
- **TUNER button**  
Selects the tuner mode.
- **TAPE button**  
Selects the MD mode.
- **CD•MD CH button**  
Selects the disc control mode.

### NOTE

The disc control mode will differ depending on the unit that is connected.

## Tuner Mode

- **Number/ letter entry buttons**

Press buttons #1-6 to recall preset stations.

During direct access tuning, use these buttons to input the frequency of the station.

- **TUNE buttons**

Press the **I◀◀** button to make decreasing seeks (using the preset tuning mode).

Press the **▶▶I** button to make increasing seeks (using the preset tuning mode).

- **AM/FM button**

Press the AM button to select the MW and LW bands.

Press the FM button to select and switch between FM1, FM2, and FM3 bands.

- **DIRECT/OK button**

Selects the direct access tuning mode, used to input frequencies directly. Press this button again to cancel the mode whilst it is operating.

During Station name preset play mode, selects station.

- **DNPP button**

Enters and cancels the Station Name Preset Play mode.

## Disc Control Mode

- **Number/ letter entry buttons**

Used to specify the track (disc) number used in direct track (disc) searches.

Used to enter letters during disc name preset.

- **TRACK buttons**

Press the **TRACK-** button to search through the tracks backwards.

Press the **TRACK+** button to search through the tracks forwards.

Used to move the cursor whilst entering disc name.

- **DISC buttons**

Press the **DISC-** button to search through the discs backwards.

Press the **DISC+** button to search through the discs forwards.

Selects numbers and symbols whilst entering disc name.

- **▶|| button**

When a disc is playing, this button pauses the play.

Press the same button again to start play again.

Selects the type of characters at the time of entering the disc name.

- **OK button**

During disc name input, stores the already input data in memory and ends the input mode.

Selects disc during the disc name preset play mode.

- **DNPP button**

Enters and cancels the Disc Name Preset Play mode.

## Basic operations of steering remote control *(See page 7)*

### ⚠ WARNING

To prevent accidents, do not attempt to use the steering remote control whilst turning the steering wheel.

### Replacing the Lithium Battery:

Use one lithium battery (CR2025). Insert the battery with the + and - poles aligned properly, following the illustration.

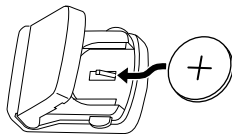

### ⚠ WARNING

Store unused lithium batteries out of the reach of children. Contact a doctor immediately if the battery is accidentally swallowed.

## All Modes

### • SRC button

Each time you press the SRC button, the mode switches as follows:

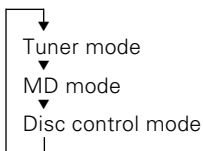

### NOTE

- The mode switches to the next mode from any mode which cannot be used.
- The disc control mode will differ depending on the unit that is connected.
- **VOLUME buttons**  
Press the ▲ button to turn the volume up.  
Press the ▼ button to turn the volume down.
- **ATT button**  
Turns down the volume quickly. To return the volume to its original level, press the button again. Turning down the volume all the way also cancels attenuation.

## Tuner Mode

### • TUNE buttons

Press the ◀◀ button to make decreasing seeks (using the preset tuning mode).

Press the ▶▶ button to make increasing seeks (using the preset tuning mode).

### • FM button

Selects and switches between the FM1, FM2 and FM3 bands.

### • AM button

Selects the MW and LW bands.

## Disc Control Mode

### • DISC buttons

Press the AM/DISC- button to search through the discs backwards.

Press the FM/DISC+ button to search through the discs forwards.

### • TRACK buttons

Press the ◀◀ button to search through the tracks backwards.

Press the ▶▶ button to search through the tracks forwards.

## Accessories

### External view

..... Number of items

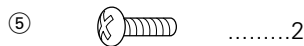
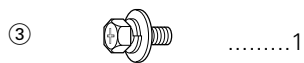
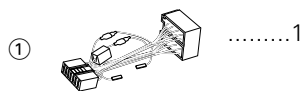

### External view

..... Number of items

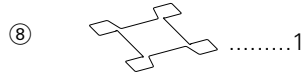
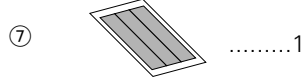
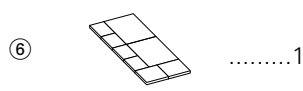

### CAUTION

The use of any accessories except for those provided might result in damage to the unit. Make sure only to use the accessories shipped with the unit, as shown above.

## Installation Procedure

1. To prevent short circuits, remove the key from the ignition and disconnect the  $\ominus$  terminal of the battery.
2. Make the proper input and output cable connections for each unit.
3. Connect the cable on the wiring harness.
4. Take Connector B on the wiring harness and connect it to the speaker connector in your vehicle.
5. Take Connector A on the wiring harness and connect it to the external power connector on your vehicle.
6. Connect the wiring harness connector to the unit.
7. Install the unit in your car.
8. Reconnect the  $\ominus$  terminal of the battery.
9. Press the reset button.

### CAUTION

- If your car is not prepared for this special connection-system, consult your KENWOOD dealer.
- Only use antenna conversion adapters (ISO-JASO) when the antenna cord has an ISO plug.
- Make sure that all cable connections are securely made by inserting jacks until they lock completely.
- If your vehicle's ignition does not have an ACC position, or if the ignition cable is connected to a power source with constant voltage such as a battery cable, the power will not be linked with the ignition (i.e., it will not turn on and off along with the ignition). If you want to link the unit's power with the ignition, connect the ignition cable to a power source that can be turned on and off with the ignition key.
- If the fuse blows, first make sure that the cables have not caused a short circuit, then replace the old fuse with one with the same rating.
- Do not let unconnected cables or terminals touch metal on the car or anything else conducting electricity. To prevent short circuits, also do not remove the caps on the ends of the unconnected cables or the terminals.
- Connect the speaker cables correctly to the terminals to which they correspond. The unit may receive damage or fail to work if you share the  $\ominus$  cables and/or ground them to any metal part in the car.
- After the unit is installed, check whether the brake lamps, indicators, wipers, etc. on the car are working properly.
- Insulate unconnected cables with vinyl tape or other similar material.
- Some disc changers need conversion cables for connection. See the section on "Safety Precautions" for details.
- If the console has a lid, make sure to install the unit so that the faceplate does not hit the lid when closing and opening.
- Mount the unit so that the mounting angle is 30° or less.

# Connecting Cables to Terminals

Connector Function Guide		
Pin Numbers for ISO Connectors	Cable Colour	Functions
<b>External Power Connector</b>		
A-4	Yellow	Battery
A-5	Blue/White	Power Control
A-6	Orange/White	Dimmer
A-7	Red	Ignition (ACC)
A-8	Black	Earth (Ground) Connection
<b>Speaker Connector</b>		
B-1	Purple	Rear Right (+)
B-2	Purple/Black	Rear Right (-)
B-3	Gray	Front Right (+)
B-4	Gray/Black	Front Right (-)
B-5	White	Front Left (+)
B-6	White/Black	Front Left (-)
B-7	Green	Rear Left (+)
B-8	Green/Black	Rear Left (-)

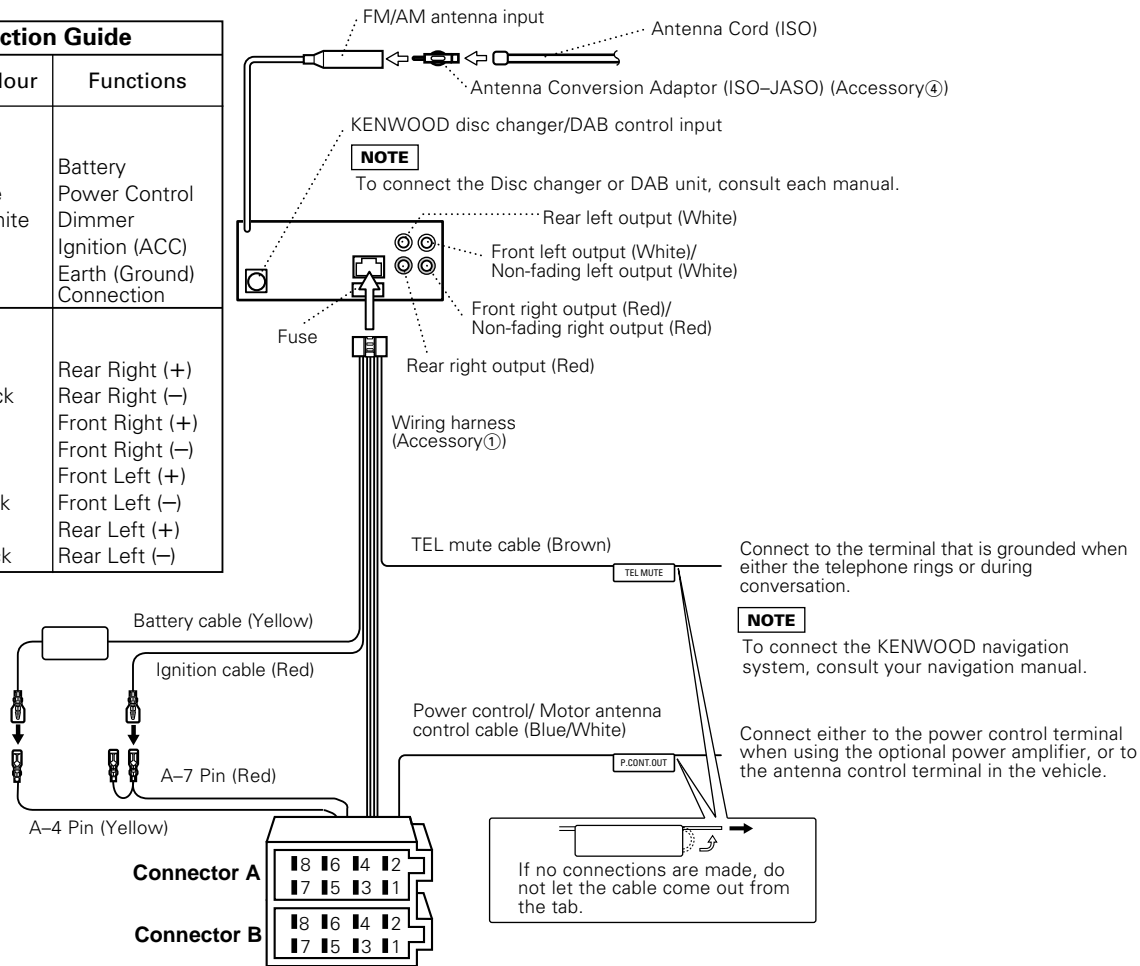

## Installation

### ■ Installation

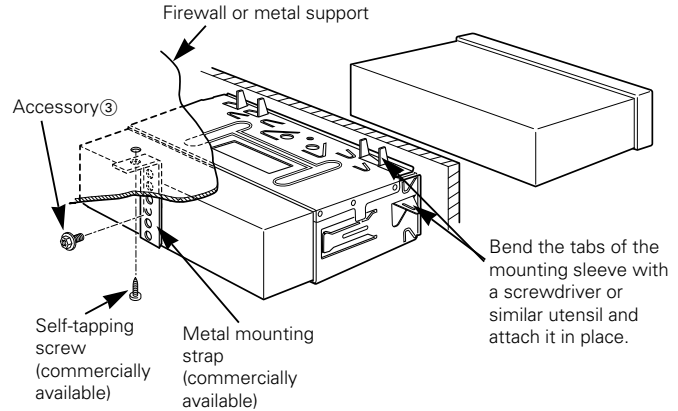

### NOTE

Make sure that the unit is installed securely in place. If the unit is unstable, it may malfunction (eg, the sound may skip).

### ⚠ WARNING Connecting the ISO Connector (see p.38)

The pin arrangement for the ISO connectors depends on the type of vehicle you drive. Make sure to make the proper connections to prevent damage to the unit.

The default connection for the wiring harness is described in [1] below. If the ISO connector pins are set as described in [2] or [3], make the connection as illustrated.

- [1] (Default setting) The A-7 pin (red) of the vehicle's ISO connector is linked with the ignition, and the A-4 pin (yellow) is connected to the constant power supply.

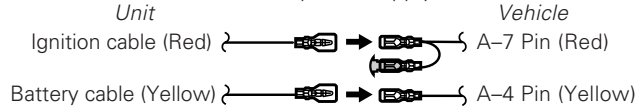

- [2] The A-7 pin (red) of the vehicle's ISO connector is connected to the constant power supply, and the A-4 pin (yellow) is linked to the ignition.

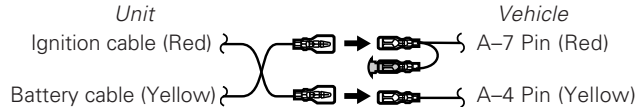

- [3] The A-4 pin (yellow) of the vehicle's ISO connector is not connected to anything, whilst the A-7 pin (red) is connected to the constant power supply (or both the A-7 (red) and A-4 (yellow) pins are connected to the constant power supply).

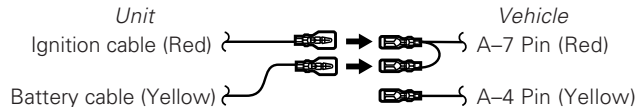

### NOTE

When the connection is made as in [3] above, the unit's power will not be linked to the ignition key. For that reason, always make sure to turn off the unit's power when the ignition is turned off.

To link the unit's power to the ignition, connect the ignition cable (ACC...red) to a power source that can be turned on and off with the ignition key.

## Installation

### ■ Screwing the Faceplate on the Unit

If you want to fasten the faceplate to the main unit so that it does not fall off, insert the provided screw ( $\varnothing 2.6 \times 12$  mm) in the holes as follows.

- 1 Insert one of the provided screws into hole① so that the screw is perpendicular to the bottom panel of the unit.
- 2 Similarly, insert another provided screw into hole②.

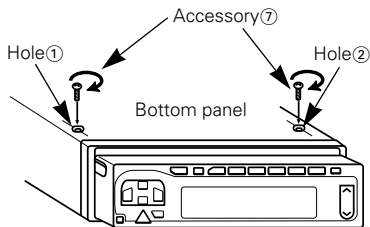

Ensure that the faceplate is fixed firmly before operating this unit.

#### ▲ CAUTION

Never insert the tapite screws ( $\varnothing 2.6 \times 12$  mm) in any other screw holes than the one specified. If you insert it in another hole, it will contact and may cause damage to the mechanical parts inside the unit.

### ■ Removing the hard rubber frame

- 1 Engage the catch pins on the removal tool and remove the two locks on the lower level.  
Lower the frame and pull it forward as shown in the figure.

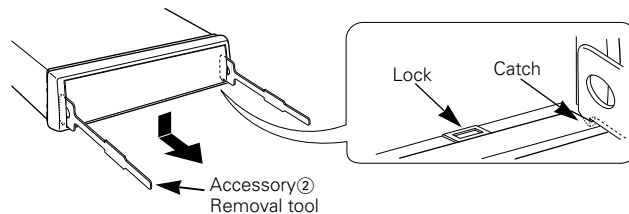

- 2 When the lower level is removed, remove the upper two locations.

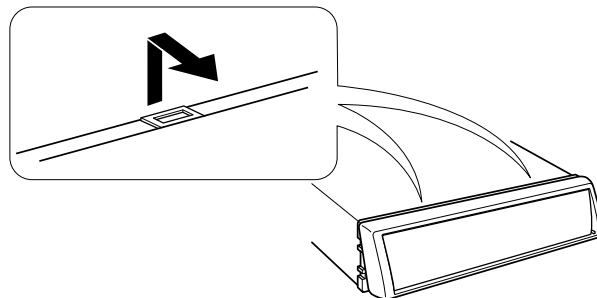

#### NOTE

The frame can be removed from the top side in the same manner.



## Attaching Steering Remote Control

### Mounting Example

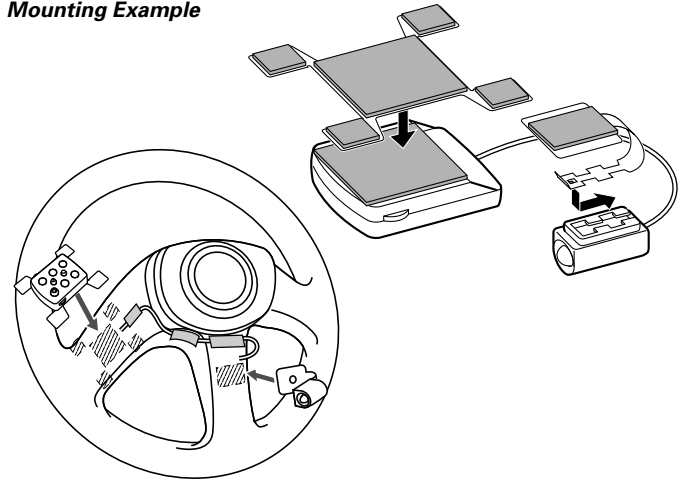

Attach the operation section and the light emitting section of the Steering Remote Control as shown above. Be sure to attach them to positions that can ensure proper operation.

#### ▲CAUTION

- Clean dirt and oil from the positions where the Steering Remote Control sections are to be attached.
- If the attached position is cold, warm it before attaching.
- The position should be selected so that the product does not come in the way of steering operation.
- Do not attach anything on the surface of a steering wheel incorporating an air bag.

## ■ Removing the Unit

- 1 Refer to the section "Removing the hard rubber frame (see p. 40)" and then remove the hard rubber frame.
- 2 Remove the Hex-head screw with integral washer (M4×8) on the back panel.
- 3 Insert the two removal tools deeply into the slots on each side, as shown.

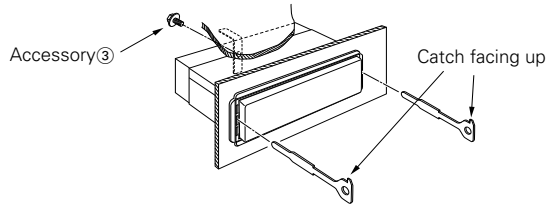

- 4 Lower the removal tool toward the bottom, and pull out the unit halfway whilst pressing towards the inside.

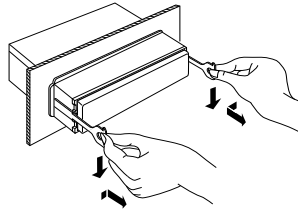

#### ▲CAUTION

Be careful to avoid injury from the catch pins on the removal tool.

- 5 Pull the unit all the way out with your hands, being careful not to drop it.

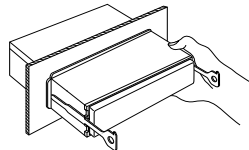

## Troubleshooting Guide

What might appear to be a malfunction in your unit may just be the result of slight misoperation or miswiring. Before calling service, first check the following table for possible problems.

PROBLEM	POSSIBLE CAUSE	SOLUTION
The power does not turn on.	The fuse has blown.	After checking for short circuits in the cables, replace the fuse with one having the same rating.
	No ACC position on vehicle ignition.	Connect the same cable to the ignition as the battery cable.
No sound can be heard, or the volume is low.	The Attenuator function is turned on.	Turn off the Attenuator function.
	The fader and/or balance settings are set all the way to one side.	Reset the fader and/or balance settings.
	The input/output cables or wiring harness are connected incorrectly.	Reconnect the input/output cables and/or the wiring harness correctly. See the section on "Connecting Cables to Terminals".
Nothing happens when the buttons are pressed.	The computer chip in the unit is not functioning normally.	Press the reset button on the unit (see page 4).
The sound quality is poor or distorted.	A speaker cable may be pinched by a screw in the car.	Check the speaker wiring.
	The speakers are not wired correctly.	Reconnect the speaker cables so that each output terminal is connected to a different speaker.
Radio reception is poor.	The car antenna is not extended.	Pull out the antenna all the way.
	The antenna control cable is not connected.	Connect the cable correctly, referring to the section on "Connecting Cables to Terminals".
The memory is erased when the ignition is turned off.	The battery cable has not been connected to the proper terminal.	Connect the cable correctly, referring to the section on "Connecting Cables to Terminals".
	The ignition and battery cable are incorrectly connected.	Connect the cable correctly, referring to the section on "Connecting Cables to Terminals".
The TEL mute function does not work.	The TEL mute cable is not connected properly.	Connect the cable correctly, referring to the section on "Connecting Cables to Terminals".
The TEL mute function turns on even though the TEL mute cable is not connected.	The TEL mute cable is touching a metal part of the car.	Pull the TEL mute cable away from the metal part of the car.
MD mode cannot be set.	The faceplate was closed whilst the MD was being ejected.	Press the eject(▲) button and reinsert the MD.
The MD cannot be inserted.	There is already an MD loaded.	Eject the currently loaded MD and then load the new one.
The MD does not load.	The insertion orientation of the MD is incorrect or the MD is upside down.	Insert the MD in the proper orientation.

<b>PROBLEM</b>	<b>POSSIBLE CAUSE</b>	<b>SOLUTION</b>
The MD loads but soon comes out again.	Nothing is recorded on the MD.	Replace the MD with one that is recorded.
The sound skips.	The mounting angle exceeds 30°.	Adjust to an angle of less than 30°.
	The mounting is unstable.	Fix the unit securely. When the sound skips at the same portion even when the car is stopped, the problem lies with the MD.
There is noise during playback.	The MD is soiled with dust or dirt.	If another MD is played back and there is no problem, then the problem is due to the sound quality of the MD itself.
The specified track does not play.	Random play has been selected.	Turn off the random play function.

### **Disc control mode**

<b>PROBLEM</b>	<b>POSSIBLE CAUSE</b>	<b>SOLUTION</b>
The disc control mode cannot be selected.	No cable has been connected to the disc changer input terminal on the unit.	Connect the cable to the disc changer input terminal on the unit.
The specified disc does not play, but another one plays instead.	The specified CD is very dirty.	Clean the CD.
	The CD is upside-down.	Load the CD with the labelled side up.
	The disc is loaded in a different slot from that specified.	Eject the disc magazine and check the number for the specified disc.
	The disc is severely scratched.	Try another disc instead.
The sound skips.	Something is touching the disc changer.	Remove whatever is touching it.
	The CD is scratched or dirty.	If skipping happens at the same place when the car is stopped, something is wrong with the CD. Clean the CD
The display shows that the changer is being played, but no sound can be heard.	The computer chip in the unit is not functioning normally.	Press the reset button on the unit (see page 4).
The specified track does not play.	Random play or magazine random play has been selected.	Turn off the random play or magazine random play function.

## Troubleshooting Guide

The following messages are displayed when certain problems are occurring in your system. Take the recommended actions.

- EJECT** No disc magazine has been loaded in the changer. The disc magazine is not completely loaded.  
⇒ Load the disc magazine properly.  
No CD in the unit.  
⇒ Insert the CD.
- NO DISC** No disc has been loaded in the disc magazine.  
⇒ Load a disc into the disc magazine.
- E-04** No disc has been loaded in the disc magazine.  
⇒ Load a disc into the disc magazine.  
The CD is very dirty. The CD is upside-down. The CD is scratched a lot.  
⇒ Clean the CD and load it correctly.
- BLANK** Nothing has been recorded on the MD.  
(For MD changer) ⇒ The next MD is automatically played back.
- NO TRACK** No tracks are recorded on the MD, although it has a title.  
(For MD changer) ⇒ The next MD is automatically played back.
- E-77** The unit is malfunctioning for some reason.  
⇒ Press the reset button on the unit. If the "E- 77" code does not disappear, consult your nearest service centre.
- E-99** Something is wrong with the disc magazine. Or the unit is malfunctioning for some reason.  
⇒ Check the disc magazine. And then, press the reset button on the unit.  
If the "E- 99" code does not disappear, consult your nearest service centre.
- HOLD** The protective circuit in the unit activates when the temperature inside the automatic disc changer exceeds 60°C (140°F), stopping all operation.  
⇒ Cool down the unit by opening the windows or turning on the air conditioner. As the temperature falls below 60°C (140°F), the disc starts playing again.
-  Nothing has been recorded on the MD you are trying to play.  
⇒ Replace this MD with one that has been recorded.  
The MD player section is not operating properly.  
⇒ Reinsert the MD. If the MD cannot be ejected or the display continues to flash even when the MD has been properly reinserted, please switch off the power and consult your nearest service centre.

## Specifications

### Specifications subject to change without notice.

#### FM tuner section

Frequency range (50 kHz Space)	87.5 MHz – 108.0 MHz
Usable sensitivity (S/N=26dB)	0.7 $\mu$ V/75 $\Omega$
Quieting Sensitivity (S/N=46dB)	1.6 $\mu$ V/75 $\Omega$
Frequency response ( $\pm$ 3.0 dB)	30 Hz – 15 kHz
Signal to Noise ratio (MONO)	65 dB
Selectivity (DIN) (400kHz)	$\geq$ 80 dB
Stereo separation (1 kHz)	35 dB

#### MW tuner section

Frequency range (9kHz Space)	531 kHz – 1611 kHz
Usable sensitivity (S/N=20dB)	25 $\mu$ V

#### LW tuner section

Frequency range	153 kHz – 281 kHz
Usable sensitivity (S/N=20dB)	45 $\mu$ V

#### MD player section

Laser diode	GaAlAs ( $\lambda$ =760 – 800 nm)
Digital filter (D/A)	8 Times Over Sampling
D/A Converter	1 Bit
Spindle speed	800 – 400 rpm (CLV)
Wow & Flutter	Below Measurable Limit
Frequency response ( $\pm$ 2 dB)	20 Hz – 20 kHz
Total harmonic distortion (1 kHz)	0.5 %
Signal to Noise ratio	80 dB (1 kHz)
Dynamic range	80 dB
Channel separation	70 dB

#### Audio section

Maximum output power	40 W $\times$ 4
Output power (DIN 45324, +B=14.4V)	27 W $\times$ 4
Tone action	
Bass:	100 Hz $\pm$ 10 dB
Treble:	10 kHz $\pm$ 10 dB
Preout level / Load	1800 mV/10 k $\Omega$
Preout impedance	$\leq$ 600 $\Omega$

#### General

Operating voltage	14.4 V (11 – 16 V allowable)
Current consumption	10.0 A at Rated power
Installation size (W $\times$ H $\times$ D)	182 $\times$ 53 $\times$ 154 mm
Weight	1.5 kg

KENWOOD